

電菱
'20.11.12
開発課

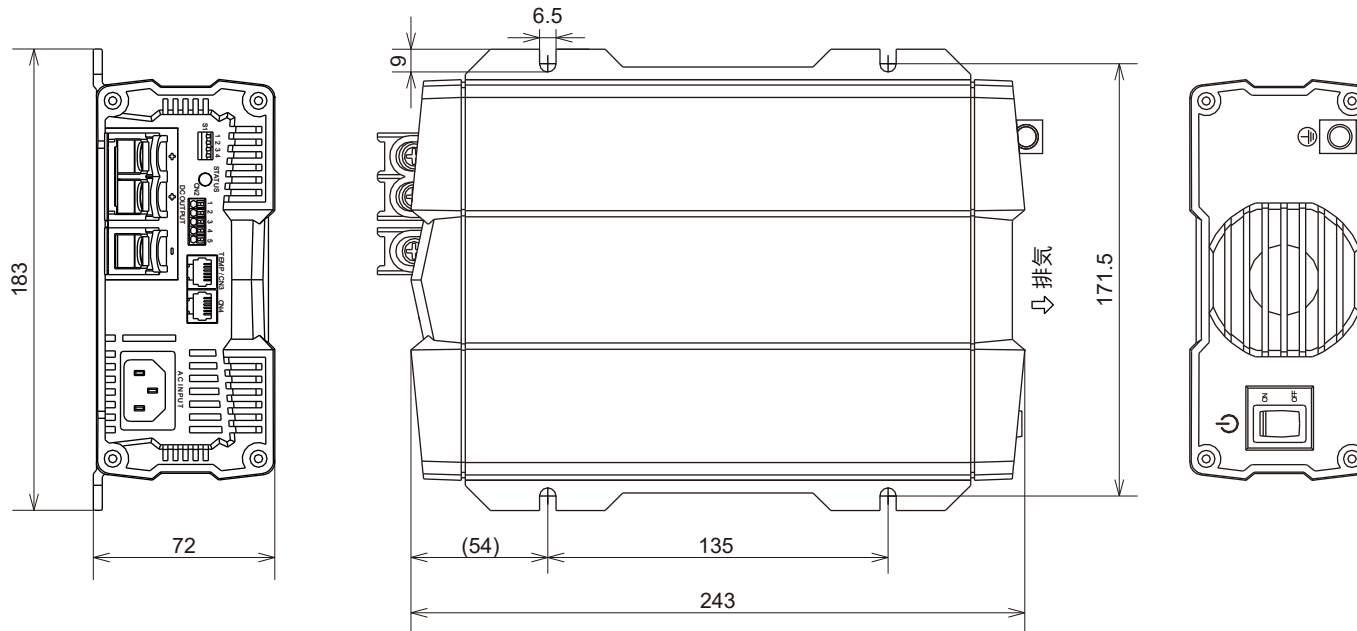

UNIT (単位) : mm

SCALE (尺度) 1:3	NAME (名称) アドバンスト充電器
TOLERANCE (公差)	
DATE (作成日) 2020.11.11	TYPE (型式) CX2415
株式会社電菱	DWG.NO. (図番) DCH-D-025

